



Critical Infrastructure Protection against High-Altitude Electromagnetic Pulse (HEMP): Will Continue to Discuss or Start Acting?

Vladimir Gurevich, Ph.D.

Central Electrical Laboratory Israel Electric Corp., Haifa, Israel

***Corresponding Author:** Vladimir Gurevich, Ph.D., Central Electrical Laboratory Israel Electric Corp., Haifa, Israel

Abstract: Protection of critical civilian infrastructure from high altitude electromagnetic pulse at nuclear explosion (HEMP) is significantly different from the protection of military facilities. Attempts to use well-known military protection means in the civilian sector have therefore failed. The article analyzes these features and describes new technical solutions designed specifically for civilian infrastructure.

Keywords: HEMP, EMP, critical infrastructure, protection

1. INTRODUCTION

The ability of the powerful electromagnetic pulse, generated upon the HEMP to destroy all electronics, has been known to nuclear physicists since the first nuclear explosion was performed in 1945 on the Alamogordo range, New Mexico (project "Trinity"). Upon the explosion, all apparatus that was meant to monitor the explosion parameters became inoperative. Upon all further test explosions performed in all countries, that electromagnetic pulse was registered precisely and was followed with the analysis and study of the parameters.

Beginning in the 1970s (50 years ago), that subject has been unclassified. At that time, dozens of Western scientific and technical reports, prepared by numerous military and civilian organizations (working at the military request), were devoted to different aspects of HEMP impact on electrical equipment and electronics. Since then, the electromagnetic pulse had been officially recognized as one of the damage effects of nuclear weapons, along with the detonation wave, the temperature, the light and the radioactive emission. At the same time, the first recommendations for the protection of electronic and electrical equipment from HEMP appeared, which, of course, were primarily intended for military equipment.

Well, what about civilian critical infrastructure protection?

2. OPINIONS

To date, we have three opposing concepts on the problem of protecting the civil critical infrastructure, which are reflected in the statements of the apologists of these three concepts:

A. Everything has been Known for a Long Time, there are no Technological Problems:

"The problem is not the technology. We know how to protect against it. It's not the money, it doesn't cost that much. The problem is the politics. It always seems to be the politics that gets in the way".

Dr. Peter Vincent Pry,

Executive Director of the Task Force on National and Homeland Security

"The U.S. military already has EMP protection approaches that are practical, affordable, tested and well understood that can be translated directly to electric power grid control facilities and supervisory control and data acquisition electronics and networks."

Dr. George H. Baker,

Prof. Emeritus James Madison University, Director Foundation for Resilient Societies

B. We have neither the Knowledge nor the Resources to Protect Infrastructures:

"Much of the available information is not specifically applied to electric utilities, making it very difficult for utilities and regulators to understand effective options for protecting energy infrastructure".

Robin Manning,

Vice president for transmission and distribution for the Electric Power Research Institute (EPRI)

"Managing that kind of threat right now — no one really has the resources to do that"

Richard Mroz,

President of the New Jersey Board of Public Utilities

C. There are no Solutions to the Problem, So You Need to Leave Everything as it is

"I don't mean to be so flippant, but there really aren't any solutions to THIS, so I would just leave it at that".

General M. V. Hayden

**Ex-Director of the National Security Agency (NSA);
Ex-Director of the Central Intelligence Agency (CIA)**

Which of them is really right?

Yes, all three, if try to use military technologies to protect civilian infrastructure! Here's just one problem: such an attempt is doomed to failure.

3. THE PROBLEMS

Today, indeed, there is all the data on how and how critical infrastructure can be protected. However, the means of protection against HEMP available on the market, made according to military standards, are not suitable for the protection of civilian infrastructure. Therefore, no one does anything in practice to protect civilian infrastructure. Everyone is right and everything is right!

But where is the way out of this paradoxical situation?

There can be only one way out of this situation: the development of protective equipment specifically designed for civilian infrastructure. But for this it is necessary to know well the structure and features of civilian infrastructure, including control cabinets with electronic equipment, relay protection, power transformers, DC power auxiliary supply system, grounding systems, Ethernet networks and much more. Therefore, it is not easy to develop protection for such a diverse range of equipment. In addition, in order to understand what means of protection are needed for civilian infrastructure, it is necessary to understand why the known military means of protection are not suitable.

In the first place, we can put the cost of military means of protection against HEMP. Take, for example, such a basic means of protection as an electromagnetic filter, Figure 1, Table 1.



Figure1. HEMP filters (left) and control cabinets (right). For size comparison.

There are several very important problems detailed in [1 – 3]. Here are some of them:

Table1. Weight and dimensions of HEMP filters from various manufacturers

Type	Nominal Current, A	Manufacturer	Dimensions, mm	Weight, kg
EEP16SPN	16	European EMC Products	560 x 200 x 112	15
LRX-2005-S2	5	ETS-Lindgren	940 x 229 x 127	27.2
LRX-2010-S2	10			
8080-2-16	16	Holland Shielding Systems BV	720 x 90 x 130	-
A-10543	10	Captor Corp.	762 x 229 x 140	-
DS33330	6	MPE Ltd.	420 x 200 x 120	10
DS33331	16			
FH1960-2W	20	LCR Electronics (Astrodyne)	762 x 305 x 127	-
FH1970-2W				
MF420-CF	10	EMI Solutions (EMIS)	750 x 150 x 110	-
GPF271C-16	16	Changzhou NoordineTech. Co.	800 x 200 x 125	-
CDSUX20210A6	10	Corcon (TE Connectivity)	533 x 203 x 127	13.6

Even single-phase two-line filters (the simplest) designed for installation into a DC or single-phase AC supply circuit featuring 3–10A costs 1.500 –2.500 US Dollars. Weight and dimensions of these filters (Table 1) worsen the situation.

The first question that surfaces upon receiving the cost information is: what is special about them? The answer can be found in specifications of these filters. The frequency range of such filters spans from dozens of kilo-hertz to as high as 20-40 GHz and the noise signal attenuation achievable within this range is up to 100 dB (i.e. 100,000 times in respect to amplitude!), Figure 2.

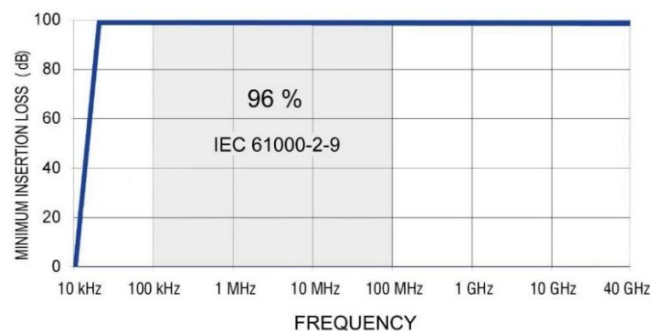

Figure2. Typical amplitude and frequency features of HEMP filters represented in ETS-Lindgren’s promotional materials.

Obviously, the broader the filter’s range, the more expensive it is. It is really difficult to provide such noise attenuation in this frequency range which! But here is the question: do we really need such a broad range for HEMP protection, if according to IEC 61000-2-9 [4] 96% of HEMP’s energy is emitted in 100 kHz–100 MHz range and 70% of the energy – in 100 kHz–10 MHz range, Figure3?

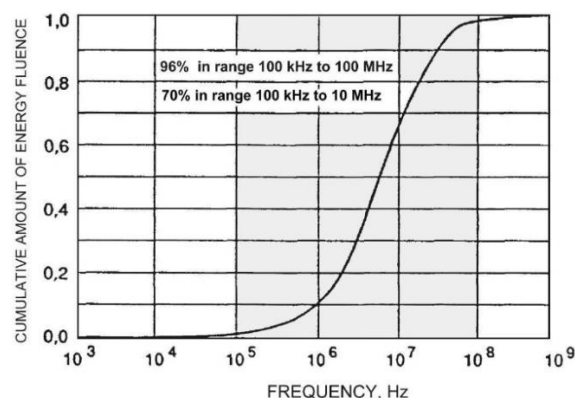

Figure3. HEMP energy distribution over the frequency range (see IEC 61000-2-9 [4])

Critical Infrastructure Protection against High-Altitude Electromagnetic Pulse (HEMP): Will Continue to Discuss or Start Acting?

Answer yes, for military installation. The military apparatus is protected within the electromagnetic range both from HEMP and Intentional Electromagnetic Interferences (IEMI), as well as from data leak through the electromagnetic fields (TEMPEST). The higher frequency range of IEMI and TEMPEST is far beyond the HEMP range (20 GHz–40 GHz). But what regarding of civilian installation? Do we need IEMI and TEMPEST protection for civilian infrastructure?

Of course, there are smaller filters (although also not cheap at all), but they all use the earth as an energy absorber for HEMP. But in fact, the earth is not such an absorber[1-3].

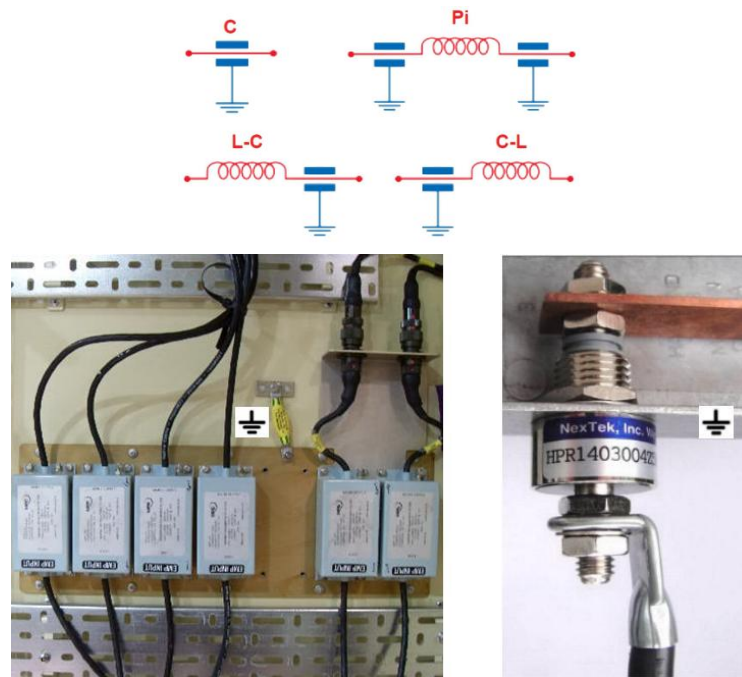

Figure4. Simplified design and appearance of various LC-filters against HEMP with parallel capacitive elements that divert impulse energy from the input to the ground

Digital protection relay cabinets, Figure 1, used in the power generation industry sometimes overstuff with apparatus, have dozens of inputs and output multicore (10 – 20 cores in a single cable) cables and each separate core requires protection. What to do about it? Cut each core of the cable and mount the filter in it? Who will attend to this?

And what to do with the grounding of each cabinet with electronic equipment and the grounding of this equipment inside the cabinet, if the grounding system itself is a huge antenna that receives EMP energy [1-3].

In addition, a many of these filters are not protected against the high amplitude of the EMP input pulses and therefore require the installation of additional surge arresters at the input, as required by the standard MIL-STD-188-125 [5], Figure 5.

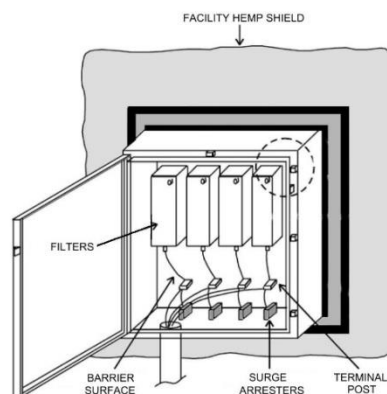

Figure5. Design of inlet box for connecting of external cable to a unit protected from HEMP (according to MIL-STD-188-125)

Special circuit diagrams for connecting the current and voltage circuits of microprocessor-based protection relays installed in cabinets require the use of HEMP filters also with special internal circuit diagrams [3].

All of the above applies only to filters taken as an example. But there are still high-power transformers that need to be protected from the E3 (GIC) component of the HEMP. Use for this purpose the only available means of protection developed by the ABB, Figure 6, which has an impressive size and cost (over 300,000 US dollars)?



Figure6. *Solid Ground™ by ABB (left) meant for blocking GIC in a neutral conductor of power transformer (right)*

What is regarding protection of modern diesel-generator with microprocessor-based control unit?

How to protect the branched DC auxiliary power supply system in substations and power plants?

What to do with the extensive Ethernet systems on substations and power plants, which is very sensitive to HEMP?

And so on and so forth... Not without reason, some experts believe that there is no solution to these problems...

4. SOLUTIONS FROM THE AUTHOR

In accordance with the specific strategy for the protection of civilian infrastructure previously proposed by the author, he also developed specific means of protection, which are installed in trial operation and have already been tested in real operation during 2 – 3 years.

On Figure 7 shows special HEMP filters intended for installation in current and voltage circuits of microprocessor-based protection relays.



Figure7. *Special HEMP filters designed by author for installation in current and voltage circuits of microprocessor-based protection relays*

In the group of these filters, there are also constructions intended to be inserting in the grounding circuits of the control cabinet and protection relays that do not violate the safety requirements for grounding circuits. These filters are designed to limit the influence of voltages induced in the grounding system under the action of HEMP.

Some filters are designed to be included in the power supply circuits of microprocessor-based protection relays inside the control cabinet, Figure 8.

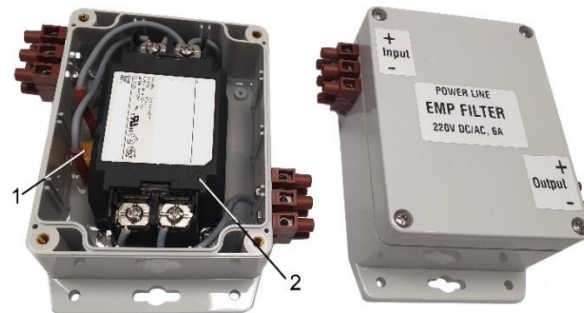

Figure8. HEMP power line filter for microprocessor-based protection relays inside the control cabinet. 1 – special high-efficiency surge arrester; 2 – electromagnetic two stage filter.

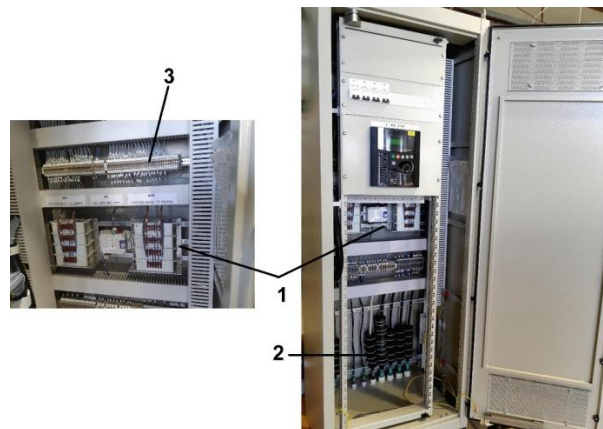

Figure9. Complete control cabinet with a microprocessor-based protection relay, filters and DIN-rail surge arresters. 1 - described above filters; 2 – addition filters; 3 – special surge arresters

A prototype of the control cabinet with a microprocessor-based protection relay, equipped with filters and special surge arresters, is shown in Figure 9.

For high-power transformers of all voltage classes, the author has developed a new protection system that consist a set of small and inexpensive components, Figure 10, as well as a simple device for periodic monitoring of the serviceability of this system during exploitation, Figure 11.

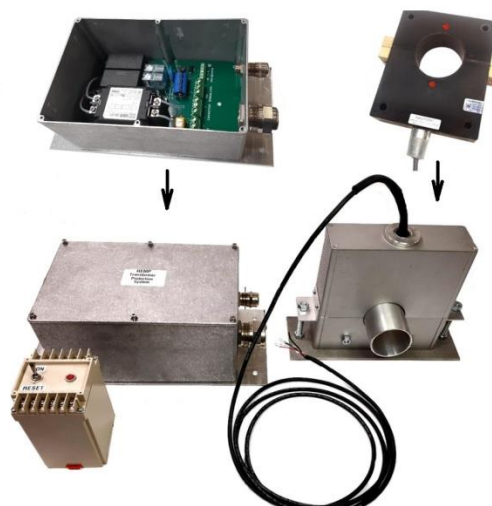

Figure10. Simple system for protection of high-power transformer against E3 component of HEMP



Figure11. Simple E3 component simulator for testing serviceability of the system for protection of high-power transformer

As known, for the operation of electronic systems of critical infrastructure, an extensive DC power auxiliary supply system is used, including large accumulator batteries and chargers. To ensure the operability of this system, the author has developed three different devices. The first of these is an automatic charger that maintains the batteries in good condition when the charger is damaged under the HEMP action, Figure 12. This device constantly monitors the serviceability of the main charger and automatically turns on in case of damage of the main charger.

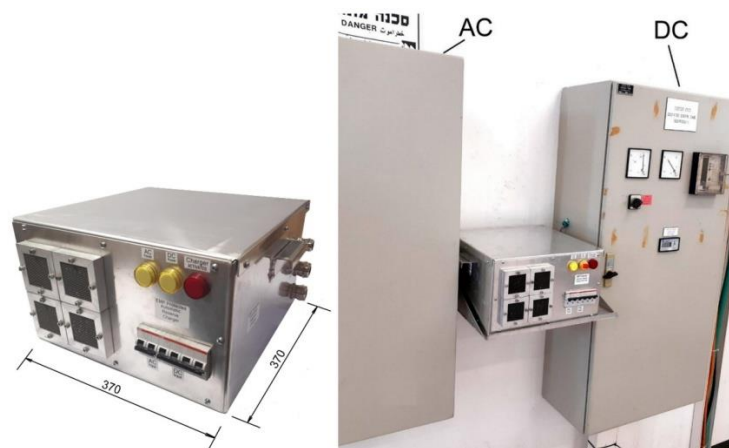

Figure12. Automatic HEMP protected charger for auxiliary DC power supply systems of critical infrastructures

Unfortunately, sometimes damage to the charger does not lead to the disappearance of its output voltage, but on the contrary, in the supply of too high voltage to the auxiliary power supply system of electronic equipment. For example, instead of the usual voltage of 237 V in the power supply system, such a damaged charger can produce a voltage of 260 - 270 V, which is dangerous for both electronic equipment and battery.

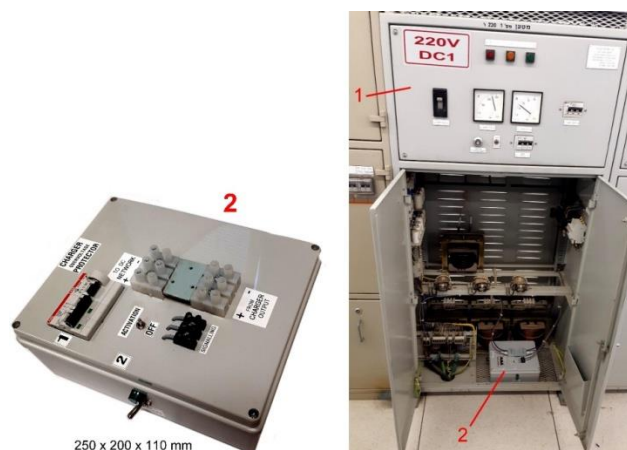

Figure13. Charger disconnection module

To prevent such a mode of the charger when it is damaged, the author has developed a small protective module that automatically disconnects such a damaged charger from the DC auxiliary supply network, Figure13. This module is also protected from the effects of HEMP. Such a module can be combined in a common design with the automatic charger described above.

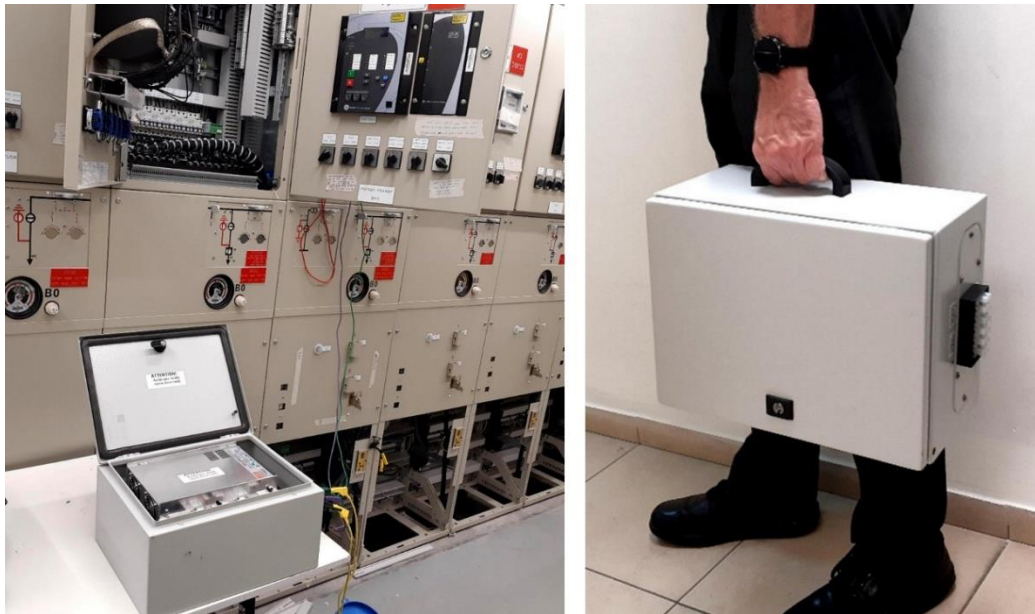

Figure14. HEMP protected backup power supply for electronic equipment testing after HEMP impact

Automatic chargers will not be installed everywhere. And after exposure to HEMP, there is a need to check the serviceability of electronic equipment before actuating. To do this, we need a power supply that simulates a conventional auxiliary DC power system. Such a backup power supply-simulator protected from HEMP is shown in Figure 14.



Figure15. HEMP protection module for telecommunications

Telecommunications are widely used in relay protection systems and other important systems at substations, power stations, and water supply systems. As a rule, it is based on 10 Base-T and 10/100 Base-TX Ethernet. This is the most vulnerable part of the infrastructure, which requires special high-effective protection. Moreover, such protection should not affect the work of telecommunication. Such a protective module was developed by the author, Figure 15, and tested for compliance with standards MIL-STD-188-125 and ITU K.78 [6].

Another important type of electrical equipment at critical infrastructure facilities is uninterruptible power supply units (UPS). To protect such type of electrical equipment, the author has developed a protection system, Figure 16.

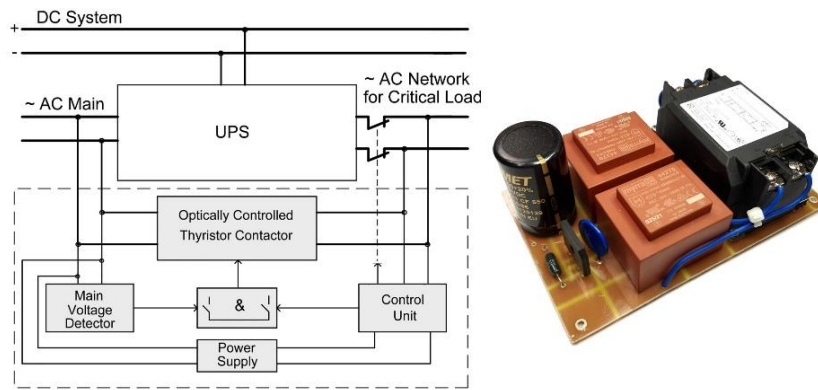

Figure16. UPS protection system and it's voltage detector

Unfortunately, not all UPS units will be protected at critical infrastructure facilities, but only the most important of them. For the rest of the UPS, a special tester (Figure 17) has been developed that allows to very easily and quickly determine the serviceability of the UPS units, exposed to HEMP.

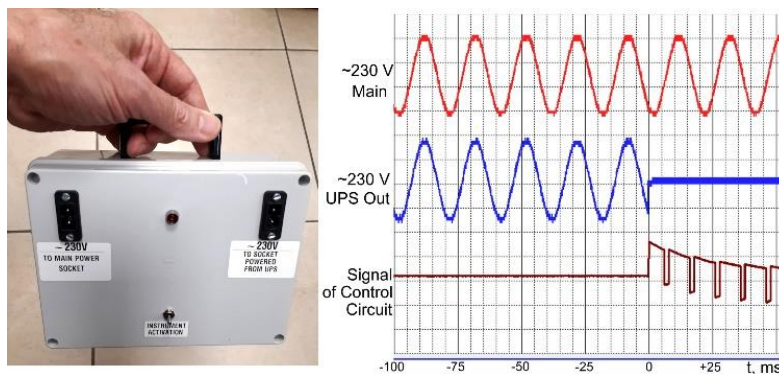

Figure17. Simple tester for express verification of the serviceability of the UPS unit after the HEMP impact.

Modern diesel generators with a capacity of 500 kW and above are often used as a backup power source at critical infrastructure facilities. Such diesel generators have a powerful electronic controller that controls all modes of operation of the diesel generator.



Figure18. Main controller of diesel generator

If this controller is damaged, the diesel generator cannot be started and operated. Moreover, this controller is made absolutely unprotected and dozens of wires are connected to it that do not have electromagnetic shielding, Figure 18. Such a “backup power supply” of critical infrastructure is not really such, since it will be disabled immediately when exposed to HEMP.

So, what to do?

For backup diesel generators, a solution was also found, Figure 19, including protection against the penetration of the electromagnetic wave through the open frames of air cooling, as well as through the power wires of the internal charger, Figure 19.



Figure19. Protection elements of the backup diesel generator, developed by the author.

The devices described above are designed specifically to protect critical civilian infrastructure, built by the author and tested. It remains only to start mass production of the developed means of protection. But will it ever be started, or will it still be just idle chatter about the dangers of HEMP and the need to do something? Will this article, like many other articles and books by the author, remain only a voice of one crying in the wilderness? I would like to hope not!

REFERENCES

- [1] Gurevich V. Protecting Electrical Equipment: GOOD Practices for Preventing High Altitude Electromagnetic Pulse Impacts. Berlin. DeGruyter, 2019.
- [2] Gurevich V. Protecting Electrical Equipment: NEW Practices for Preventing High Altitude Electromagnetic Pulse Impacts. Berlin. DeGruyter, 2021.
- [3] Gurevich V. Nuclear Electromagnetic Pulse: Practical Guide for Protection of Critical Infrastructure. – Lambert Academic Publisher, London, 2023.
- [4] MIL-STD-188-125-1 High –Altitude Electromagnetic Pulse (HEMP) Protection for Ground Based C⁴I Facilities Performing Critical. Time-Urgent Mission. Part 1 Fixed Facilities, 2005.
- [5] IEC 61000-2-9 Electromagnetic compatibility (EMC) - Part 2: Environment - Section 9: Description of HEMP environment - Radiated disturbance. Basic EMC publication, 1996.
- [6] ITU K.78. High Altitude Electromagnetic Pulse Immunity Guide for Telecommunication Centres. - International Telecommunication Union, 2016.

Citation: Vladimir Gurevich, Ph.D.. “Critical Infrastructure Protection against High-Altitude Electromagnetic Pulse (HEMP): Will Continue to Discuss or Start Acting?”, *International Journal of Research Studies in Electrical and Electronics Engineering (IJRSEEE)*, 8(1), pp.1-10, DOI: <http://dx.doi.org/10.20431/2454-9436.0801003>.

Copyright: © 2023 This is an open-access article distributed under the terms of the Creative Commons Attribution License, which permits unrestricted use, distribution, and reproduction in any medium, provided the original author and source are credited