

Cognitive Analytics and Comparison of Symmetric and Asymmetric Cryptography Algorithms

D Paul Joseph¹, M Krishna², K Arun³

C.R Reddy College of Engineering¹
Assoc. Professor, C.R Reddy College Of Engineering²
Assoc. Professor, SSN Engineering College³

Abstract: Today is the era of Internet and networks applications. So the Information Security has been very important issue in data communication. Any loss to information can prove to be great loss to the organization. Encryption has come up as a solution, and plays a vital role in information security system. Many techniques are needed to protect the shared data. The present work focus on cryptography to secure the data while transmitting in the network. First the data which is to be transmitted from sender to receiver in the network must be encrypted using the encryption algorithms. Secondly, by using decryption techniques the receiver can view the original data. This paper provides a comparison between five most common and used symmetric and asymmetric key algorithms: DES, 3DES, AES, RSA and MD5 algorithms and comparison has made based on their performance and time of encryption and decryption, block size, key size, and encryption/decryption time, in the form of throughput

Index Terms: Encryption, Decryption, private key, public key, DES, 3DES, AES, RSA, MD5 Introduction.

1. INTRODUCTION

In present world, numerous algorithms are designed and developed to provide security to the information that is spread across globally through network. These algorithms can be mainly classified as Symmetric and Asymmetric algorithms. The important issue that differentiates them is usage of keys. In symmetric algorithms, only one key is used and it is termed as private key. In other words, symmetric algorithms are also termed as private key algorithms as they use private key both for encryption and decryption.

Asymmetric key algorithm uses two keys, which can be defined as private key and public key. Private Key is used for encryption purpose whereas public key is used for decryption purposes. These algorithms are also called as public key algorithms. In advantage to private key, public key algorithms uses computational and complex mathematical methods

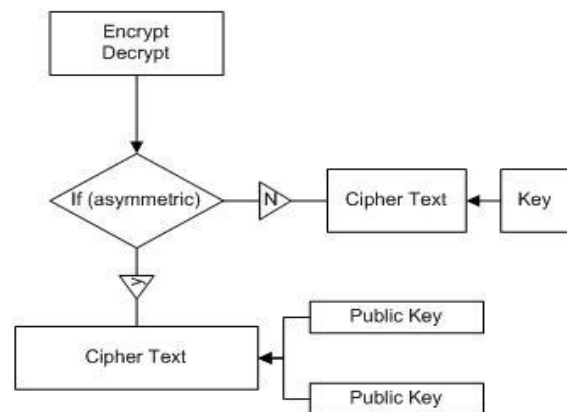

Fig1. Symmetric and Asymmetric Techniques

2. SYMMETRIC ALGORITHMS

In symmetric key algorithms, the same key is used for both encryption and decryption. Simply it can be understood as both the sender and the receiver uses same key to send or receive the message. Typically there are few algorithms which fall under this category. These can be classified as:

- Rot13
- Caesar cipher
- DES
- 3DES
- AES
- Skipjack.

3. DATA ENCRYPTION STANDARD ALGORITHM

The DES algorithm based on LUCIFER, designed by Horst Feistel, was developed at IBM in 1972. This algorithm was approved by the National Bureau of Standards (now NIST) after assessment of DES strength and modifications by the National Security Agency (NSA), and became a Federal standard in 1977.

Features:

- Block Size:64bit
- Key size=56bits(in reality,64bits)
- Number of rounds=16
- 16intermediarykeys,each48bits
- In DES, in each byte, the 8th bit is parity-check bit.

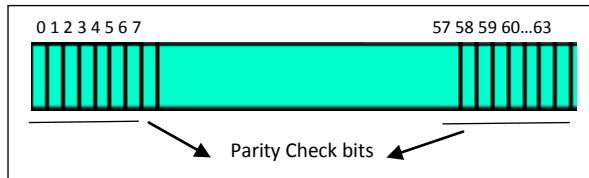

Fig2. Parity Check Bits

Each parity-check bit is the XOR of previous bit. In DES, 16cycle Feistel system is used, with an overall56- bit key permutedinto1648-bitsubkeys, one for each cycle. For decryption, the same algorithm is used, with the order of sub keys reversed.

The Left and Right blocksare32bitseach (4bytes), totaling an overall block size of 64bits.Thehashfunction "f", uses "S-boxes", which takesa4-bytedatablock andoneofthe6-bytesubkeys as input and produces 4bytesofoutput.

- DESuses1648-bitkeys generatedfromamaster56-bit key (64bitsifweconsideralsoparitybits)
- Weakkeys: keys make the same sub-key to be generated in more than one round
- Result:reduceciphercomplexity
- Weakkeys can be avoided at key generation.
- DEShas4weakkeys
 - 0101010101010101
 - FEF EFEFEFEFEFEFEFE
 - E0E0E0E0F1F1F1F1
 - 1F1F1F1F0E0E0E0E
- Using weakkeys, the outcome of the Permuted Choice1(PC1)in the DES key schedule leads to round keys (K1---K16) being either all zeros, all ones or alternating zero-one patterns.
- Since all the sub keys are identical, and DESisa Feistel network, the encryption function becomes self-inverting; that is, encrypting twice with a weakkeyK produces the original plain text.
- $-EK(EK(x)) = x$ for allx, i.e., the encryption and the decryption are the same

4. TRIPLE DATA ENCRYPTION STANDARD ALGORITHM

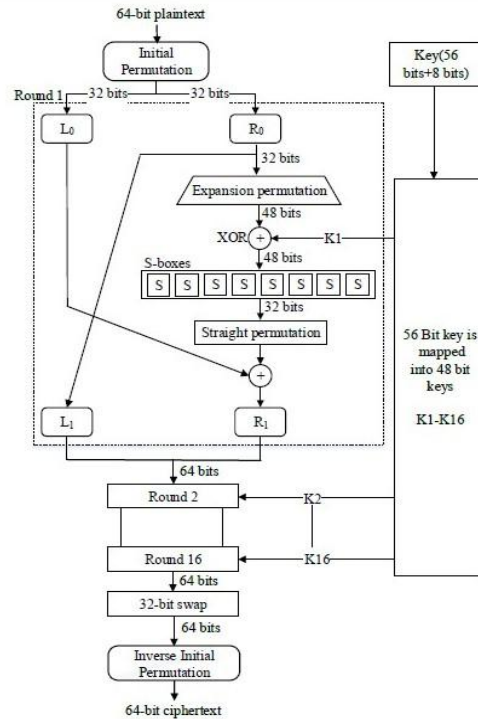

Fig3. Structure of DES

3DES is the enhanced version of the DES algorithm. Since the DES seemed to be less efficient because of dictionary and brute force attacks, design of new algorithm was essential. In 3DES, it follows three steps.

For encryption it follows:

Encryption – Decryption - Encryption

For decryption it follows:

Decrypt – Encrypt – Decrypt.

Features:

- Block size:64bits
- Cipher: Symmetric Block Cipher
- Key length:168 bits
- Keys:3keys(each of 64bit)

This standard specifies three keying options:

- Keyingoption1: All three keys are independent.
- Keyingoption2: K₁and K₂are independent, and K₃=K₁
- Keying option3:All three keys are identical, i.e. K₁=K₂=K₃
- Keying option1:thekeyspaceis56x3=168bits.
- Keying option2 provides less security than option1, with2×56=112key bits.

- Keying option3 is equivalent to DES, with only 56 key bits. This option provides backward compatibility with DES.

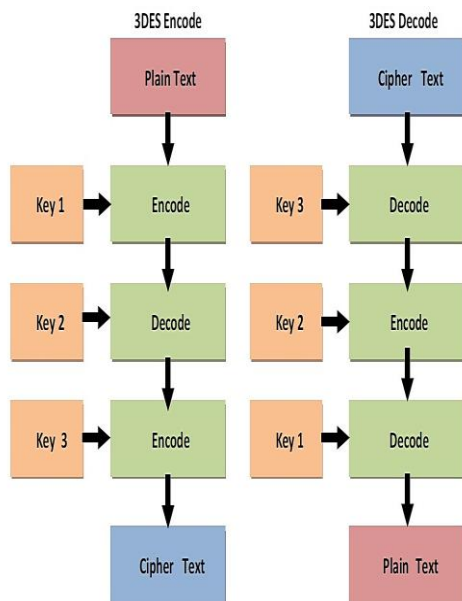

Drawbacks:

- Encrypt: $C = EK3 [DK2 [EK1 [P]]]$
- Decrypt: $P = DK1 [EK2 [DK3 [C]]]$

If we use three completely different keys, will there be 168bits effectively strength?

5. ADVANCED ENCRYPTION STANDARDS ALGORITHM

The Advanced Encryption Standard (AES) specifies a FIPS-approved cryptographic algorithm that can be used to protect electronic data. The AES algorithm is a symmetric block cipher that can encrypt (encipher) and decrypt (decipher) information. Encryption converts data to an unintelligible form called cipher text; decrypting the cipher text converts the data back into its original form, called plaintext.

The AES algorithm is capable of using cryptographic keys of 128, 192, and 256 bits to encrypt and decrypt data in blocks of 128 bits. The algorithm specified in this standard may be implemented in software, firmware, hardware, or any combination thereof. The specific implementation may depend on several factors such as the application, the environment, the technology used, etc. The algorithm shall be used in conjunction with a FIPS approved or NIST recommended mode of operation.

- Block Size: 128bits
- Key size: 128,192 and 256 bits.
- Encryption: 10rounds of Encryption for 128bit.
- 12 Rounds for 192 bit,14 for 256bit

- 128bit key is XORed with 128bit of plain text
- Consists of Four Operations:
 - Substitute Bytes
 - Shift Rows
 - Mix Columns
 - Add Round Key

A. Substitute Bytes:

In AES algorithm the function of the sub byte is only nonlinear function and that operates independently on each byte of the state using a substitution table (Sbox).It substitutes all bytes of the state array using a LUT which is a 16x16 matrix of bytes, often called S-box Units

B. Shift Rows:

As transformation is almost the same in the decryption process except that the shifting off sets have different values. The main goal of this process is to correlate and scramble the byte order inside each 128-bit block. In the shift the bytes in the last three rows of the State are cyclically shifted over different numbers of bytes (offsets). In this process the row 0 is not shifted, row 1 is shifted one byte to the left, row 2 is shifted two bytes to the left and row 3 is shifted three bytes to the left.

C. Mix Column Transformation:

This transformation is based on Galois Field multiplication. Each byte of a column is replaced with another value that is a function of all four bytes in the given column. The Mix Columns transformation is performed on the State column-by column.

In AES algorithm the function of the sub byte is only nonlinear function and that operates independently on each byte of the state using a substitution table (Sbox). It substitutes all bytes of the state array using a LUT which is a 16x16 matrix of bytes, often called S-box Units

D. Shift Rows:

As transformation is almost the same in the decryption process except that the shifting off sets have different values. The main goal of this process is to correlate and scramble the byte order inside each 128-bit block. In the shift the bytes in the last three rows of the State are cyclically shifted over different numbers of bytes (offsets). In this process the row 0 is not shifted, row 1 is shifted one byte to the left, row 2 is shifted two bytes to the left and row 3 is shifted three bytes to the left.

E. Mix Column Transformation:

This transformation is based on Galois Field multiplication. Each byte of a column is replaced with another value that is a function of all four bytes in the

given column. The Mix Columns transformation is performed on the State column-by-column.

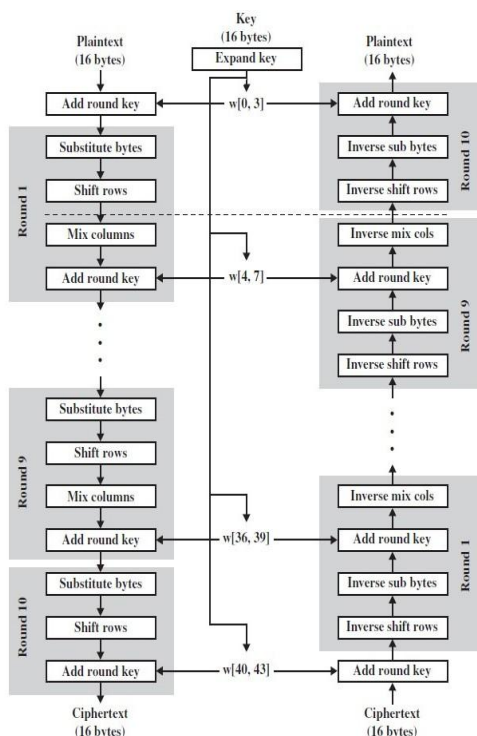

Fig5. Structure of Advance Encryption Standard Algorithm

F. Add Round Key:

In this operation, the round key is applied to the State by simple bit by bit XOR. Key Expansion unit generates the next round key as for three different key size. AES consist of 10, 12 or 14 rounds. After every round a new round key is produced. This process utilizes the concept of shifting the bytes and substitution of bytes which were used in data processing unit.

6. DISADVANTAGES OF SYMMETRIC TECHNIQUES

A major problem with such a system is that the sender and receiver must know the key prior to transmission. This requirement makes such a system difficult to use in practice. The key cannot be openly transmitted since that would compromise the security of system. One possibility is for the two parties to meet and exchange the keys prior to transmitting their messages. However, this exchange becomes more difficult when many parties are involved in a communications network.

Secondly, most of the symmetric algorithms contains more number of rounds, which leads to large processing time.

Thirdly, these algorithms contains a bit of smaller block sizes, which may leads to numerous times of block division.

Since these contains only single key for all transmissions, if that key is anyhow known, then whole transmission would be a failure.

7. ASYMMETRIC ALGORITHMS

Asymmetric cryptography algorithms uses two keys which can be referred as public key and private key. Public key is used for encryption purpose and private key is used for decryption purpose. These two keys are mathematically related, but it is very difficult to obtain one from the other unless one knows the transformation. The public key can be revealed without compromising the security of the system. The corresponding private key, however, must not be revealed to any party. Currently information is electronically processed and conveyed through public networks. The main objective of cryptography is, to conceal the content of messages transmitted through insecure channels such that it guarantees privacy and confidentiality in the communications to the authorized users. The different algorithms designed under this category are RSA, MD5 and SHA.

8. RIVEST, ADISHAMIR, AND LEONARD ADLEMAN ALGORITHM

RSA is designed by Ron Rivest, Adi Shamir, and Leonard Adleman in 1978. It is one of the best known public key cryptosystems for key exchange or digital signatures or encryption of blocks of data. RSA uses a variable size encryption block and a variable size key, based on number theory, which is a block cipher system. It uses two prime numbers to generate the public and private keys. These two different keys are used for encryption and decryption purpose. Sender encrypts the message using Receiver public key and when the message gets transmit to receiver, then receiver can decrypt it using his own private key.

Key Generation Procedure:

- Choose two distinct larger and omprime numbers p & q such that $p \neq q$.
 - Compute $n = p \times q$.
 - Calculate: $\phi(n) = (p-1)(q-1)$.
 - Choose an integer e such that $1 < e < \phi(n)$
 - Computed to satisfy the congruence relation $d \times e = 1 \pmod{\phi(n)}$; d is kept as private.
- The public key is (n, e) and the private key is (n, d) . Keep d, p, q and ϕ secret.

Encryption text: $P < n$ Cipher text: $C = P^e \pmod{n}$.

Decryption text: C, Plaintext: $P = C^d \pmod{n}$.

RSA encryption is a deterministic encryption algorithm (i.e., has no random component) an attacker can successfully launch a chosen plaintext attack against the cryptosystem, by encrypting likely plaintexts under the public key and test if they are equal to the cipher text.

RSA has the property that the product of two ciphertexts is equal to the encryption of the product of the respective plaintexts. That is $m_1^e m_2^e \equiv (m_1 m_2)^e \pmod{n}$. Because of this multiplicative property a chosen-ciphertext attack is possible.

E.g., an attacker, who wants to know the decryption of a ciphertext $c \equiv m^e \pmod{n}$ may ask the holder of the private key to decrypt an unsuspecting-looking ciphertext $c' \equiv cr^e \pmod{n}$ for some value r chosen by the attacker. Because of the multiplicative property c' is the encryption of $mr \pmod{n}$. Hence, if the attacker is successful with the attack, he will learn $mr \pmod{n}$ from which he can derive the message m by multiplying mr with the modular inverse of r modulo n .

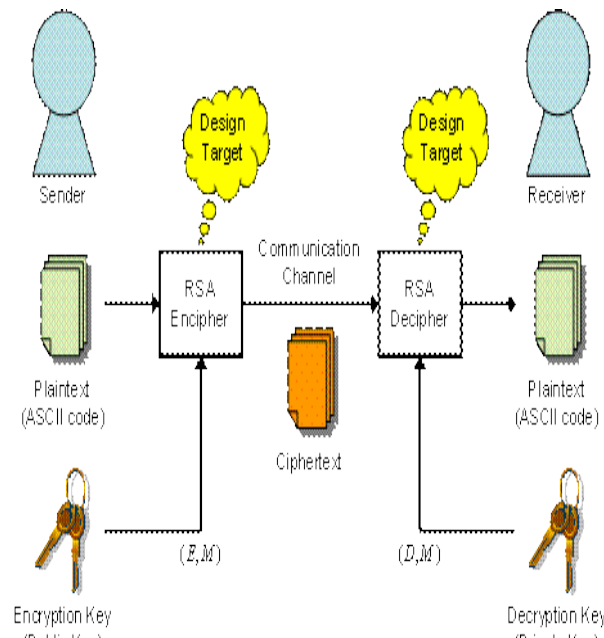

Fig6. Structure of RSA Algorithm

9. MESSAGE DIGEST ALGORITHM

The MD5 message-digest algorithm is a widely used cryptographic hash function producing a 128-bit (16-byte) hash value, typically expressed in text format as a 32 digit hexadecimal number. MD5 has been utilized in a wide variety of cryptographic applications, and is also commonly used to verify data integrity.

Advantages of MD5:

- Utilizes a fast computation algorithm
- Provides collision resistance
- Is in widespread use
- Provides a one-way hash.

MD5 is one in a series of message digest algorithms designed to be a secure replacement for MD4. But later Md5 was proved that it was vulnerable to Collision Resistant, Preimage Vulnerability and some other vulnerabilities. In addition it was also not

applicable to SSL certificates and Digital certificates. Has known security flaws and vulnerabilities. It is less secure than the SHA-1 algorithm.

MD5 uses the Merkle–Damgård construction, so if two prefixes with the same hash can be constructed, a common suffix can be added to both to make the collision more likely to be accepted as valid data by the application using it.

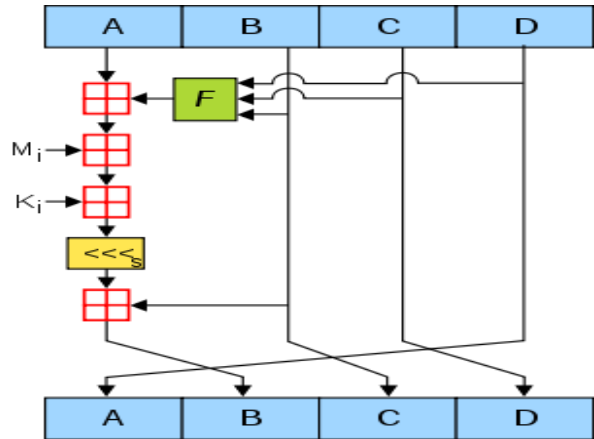

Fig7. Structure of Message Digest Algorithm

An example MD5 collision, with the two messages differing in 6 bits, is shown in below figures:

```
d131dd02c5e6eec4 693d9a0698aff95c
2fcab58712467eab 4004583eb8fb7f89
55ad340609f4b302 83e488832571415a
085125e8f7cdc99f d91dbdf280373c5b
d8823e3156348f5b ae6dacd436c919c6
dd53e2b487da03fd 02396306d248cda0
e99f33420f577ee8 ce54b67080a80d1e
c69821bcb6a88393 96f9652b6ff72a70
```

```
d131dd02c5e6eec4 693d9a0698aff95c
2fcab50712467eab 4004583eb8fb7f89
55ad340609f4b302 83e4888325f1415a
085125e8f7cdc99f d91dbd7280373c5b
d8823e3156348f5b ae6dacd436c919c6
dd53e23487da03fd 02396306d248cda0
e99f33420f577ee8 ce54b67080280d1e
c69821bcb6a88393 96f965ab6ff72a70
```

10. COMPARISON OF SYMMETRIC AND ASYMMETRIC ALGORITHMS

- Larger the block size → slower execution
- Larger key size → High security
- Increased Rounds → more execution time
- Larger key size → more arithmetical operations
→ More consumption of time

Table1. Symmetric versus Asymmetric

Algorithms	DES	3DES	AES	RSA	MD5
Author	IBM	IBM	JoanDaemen, Incent Rijmen	Rivest, Shamir, Adleman	Ronald Rivest
Year	1975	1978	1998	1977	1992
Structure	Festial	Festial	Substitution Permutation	Public key algorithm	Merkle Damgard
Rounds	16	48	10, 12, 14	1	4
Key (bits)	56	168	128, 192, 256	Greater than 1024bits	512
Block size (in bits)	64	64	128	128	512
Security	Vulnerable	Adequate vulnerable	Strongly ciphered	High security	Moderately secured
Execution speed	Moderate	Moderate	Faster	Slower	Moderate
Vulnerabilities	Brute-Force, Cryptanalysis	Cryptanal ysis	Brute force(not yet proved)	Oracle attacks	Collision, Preimage vulnerability
Power Consumption	Low	Low	Low	High	Moderate
Encryption / Decryption speed	Moderate	Moderate	Faster	Low	Faster
Possible Keys	2^{56}	$2^{112}, 2^{168}$	$2^{128}, 2^{192}, 2^{256}$	2^{128}	2^{512}

11. CONCLUSION

In this paper a new comparative study between DES, 3DES, AES, RSA and MD5 were represented on various factors which are key length, cipher type, block size, developed, possible keys. Overall theoretical and practical simulation experiments proved AES is better in terms of execution speed, consumption of time, Time to break the algorithm and security. Our future work will focus on comparison of existing cryptographic algorithms and it will include practicality on image and audio data further more resulting for the advanced encryption techniques.

REFERENCES

[1]. Xinmiao Zhang and Keshab K. Parhi “Implementation Approaches for the Advanced Encryption Standard Algorithm” IEEE 2002

[2]. Dawn Xiaodong Song David Wagner Adrian Perring “Practical Techniques for Searches on Encrypted Data” Security and Privacy, 2000. S&P 2000. Proceedings. 2000 IEEE Symposium on 2002.

[3]. Chia Long Wu, Chen Hao Hu, “Computational Complexity Theoretical Analyses on Cryptographic Algorithms for Computer Security Application”

[4]. Abdel-Karim Al Tamimi, Swati.” Performance Analysis of Data Encryption Algorithms “,

International Journal of Advanced Research in Computer Science and Software Engineering 3(2), pp. 147-149, February – 2013.

[5]. Nidhi Singh1, J.P.S.Raina2,” Comparative Analysis of AES and RC4 Algorithms for Better Utilization”, International Journal of Computer Trends and Technologypp.177-181, Aug 2011.

[6]. Pratap Chandra Mandal, “ Evaluation of performance of the Symmetric Key Algorithms: DES, 3DES ,AES and Blowfish “, Journal of Global Research in Computer Science Department of Computer Application, vol 3, pp 67-70, August 2012